

AFTERCARE INSTRUCTIONS

Excessive exposure to water will deteriorate the furniture. Wipe away any water splashes or condensation after use.

All bathrooms should be well ventilated, if needed, with a suitable extractor fan.

Clean with a soft damp cloth only.

Use a wax free polish if one must be used.

All electrical components are IP44 rated.

Do not allow water to come into contact with the electrical components.

CUSTOMER SERVICE

t: +44 208 686 5100

e: sales@saneux.com

Iain Stewart Centre, Gatwick,
Beehive Ring Road, RH6 0PB

www.saneux.com



REGENCY

INSTALLATION INSTRUCTIONS

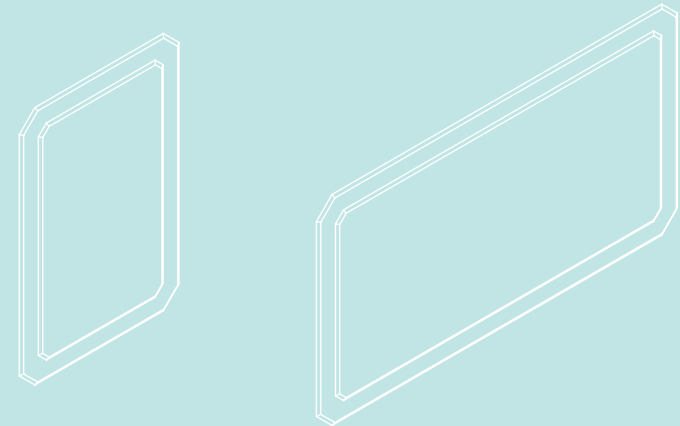



RE040M, RE090M, RE130M

saneux

Before drilling, ensure there are no hidden cables or pipes in the wall.

Throughout the entirety of the installation process, make sure that the domestic electrical mains supply to which the product is being connected is turned off.

-  x5 Ø4 x 40mm Screw
-  x5 Ø7.5 x 35mm Wall plug

WIRING DIAGRAM

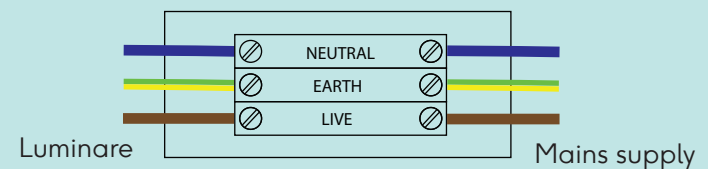

- The Neutral supply can be Blue or Black.
- The Earth supply is Green and Yellow.
- The Live supply cable can be Red or Brown.

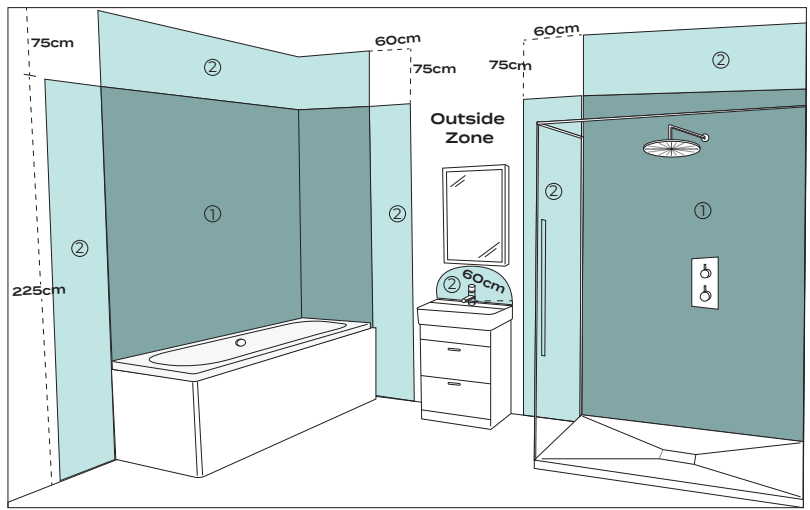

All electrical bathroom products should be fitted by a qualified electrician.

This product is only suitable for the 'Outside zone' indicated in the image above.

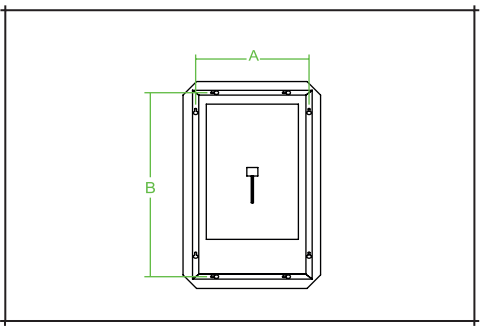

Choose the orientation for the mirror, then measure distance A or B. Mark the 2 points on the wall, ensuring that the holes are level.

NOTE: Check there are no hidden pipes or cables behind the wall before drilling.

Line the wall brackets up with the wall markings and mark the locations of the holes. Proceed by drilling the marked holes.

Secure the brackets to the wall ensuring they are level.

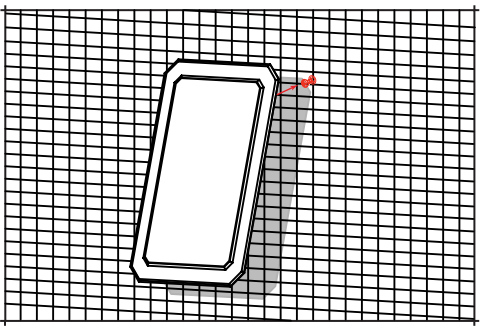
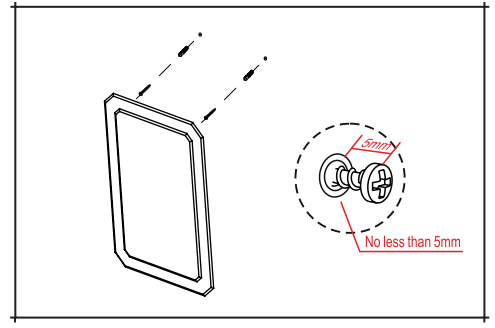

Before hanging the mirror make the electrical connection at the rear of the mirror.

Carefully hang the mirror in place, locating the the frame onto the brackets. Ensure the mirror is fully secured onto the mounting holes before letting go.

The mirror is operated via the mains.

