

THERMOSTATIC BAR VALVE INSTALLATION INSTRUCTIONS

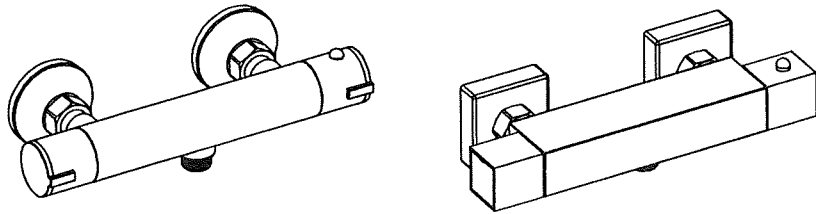

IMPORTANT

1. We recommend that this product is installed by a qualified professional contractor, such as a plumber who is certified by NVQ (National Vocational Qualification) or SNVQ (Scottish National Vocational Qualification) Level 3.
2. Please check this product immediately to ensure that it has not been damaged and is complete. Before installation, please make sure this product is the correct model and you have all the parts required for installation and using.
3. All the valves should be supplied with hot and cold water at balanced pressure. If not, then the mixing function will not work correctly. It is necessary to fit non-return valves on both hot and cold fed pipes.
4. Please flush the water system to ensure that no metal swarf, solder, and other impurities can enter the valves.
5. Turn off water supply before commencing work, this should be done at the isolating valves of inlet feeds if fitted or main stopcock.
6. Please read these instructions carefully and keep it for future reference.

WORKING PRESSURE AND TEMPERATURE

The valve is suitable for both high and low pressure installation. To ensure that the valve works well under low water pressure, the cold water storage tank must be at least 2 meters above the installed position.

Maximum Static Pressure: 10 Bar
 Flow Pressure, Hot & Cold: 0.5-5 Bar
 Hot Supply Temperature: 55-65 °C
 Cold Supply Temperature: 5-25 °C

COMPONENTS AND DIMENSION DRAWING

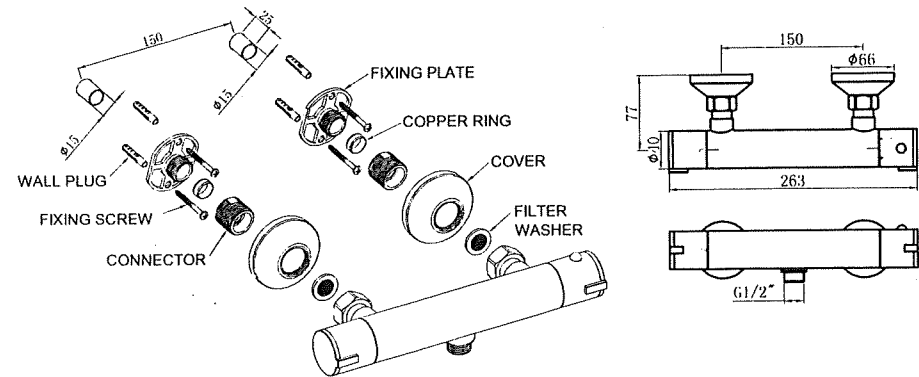

The valve should be installed in accordance with the water bye-laws. For further details refer to the latest copy of Water Bye-laws guide or your local water authority.

1. Place two fixing plates on hot & cold inlets and mark fixing holes, drill four holes of $\phi 8$ mm diameter with depth of 45mm.
2. Fix the fixing plates against wall, put in wall plugs and fixing screws with screwdriver. Place copper rings inside the fixing plates, then tighten and seal with connector. Finally put wall covers on and tighten properly.
3. Place filter mesh inside the inlets of bar valve. Fix connectors of bar valves to the easy fit with spanner.

Please use a cotton sheet inside of spanner in case of any scratches. Make sure hot inlet on the left and cold inlet on right, otherwise it will affect the performance.

TEMPERATURE SETTING

The temperature control handles on this product are factory set and should require no adjustment.

However, if for any reason the handles and/or the cartridge is removed, it is important the following procedures are followed.

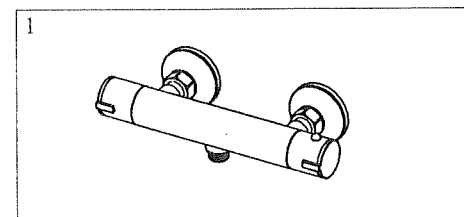

- 1) Quarter-turn the handle on the right anti-clockwise, the water will come out.
- 2) Allow the water temperature to stabilize around 3 minutes and check the temperature by thermometer.
- 3) Proceed if temperature is not 38°C.

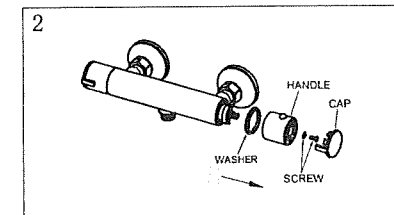

- 1) Take off the cap.
- 2) Untighten the screw.
- 3) Get out the handle and washer.

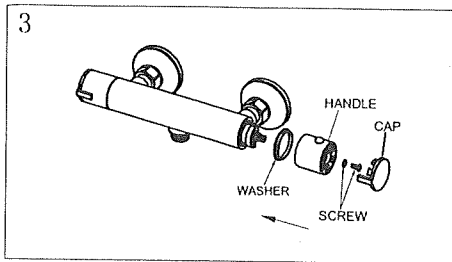

- 1) Turn on the valve.
- 2) Temperature is up when valve stem is turned clockwise, temperature is down when valve stem is turned anti-clockwise.
- 3) When temperature is correctly set, fix the handle back to the valve as show above.
- 4) Tighten the screw, adjust the handle properly, then fix the cap to the handle.

MAINTENANCE (THERMOSTATIC CARTRIDGE)

* After a long time usage of thermostatic valve, there will be some waste or debris from the water pipe on and around the thermostatic cartridge, which will affect the flow and sensitivity of automatical temperature adjustment. Please take out the thermostatic cartridge and clean the cartridge strainer

* To avoid damage, please remove all chrome parts before any maintenance takes place.

- 1) Take off the cap, untighten the screw, to get out handle and washer. Then get out plastic block. (See Fig. 1)
- 2) Untighten the cartridge clamp nut to take out the cartridge. (See Fig. 2)
- 3) Wash the cartridge with clean running water, dry and lightly grease the seals (only use silicone grease).
- 4) Replace the cartridge and make sure it back to the primary position.

* Cartridge Type: " H104 " is the spare part number of thermostatic cartridge.

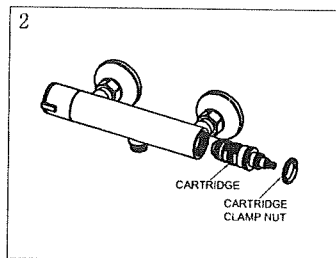
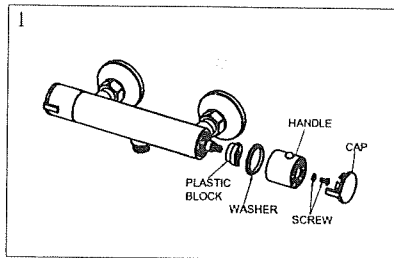

TROUBLE SHOOTING

1. Output water temperature does not correspond with temperature set
Cause: Thermostat has not been adjusted base on the existing home water system
Remedy: Adjust the thermostat, refer to "Temperature Setting" procedure.
Cause: Hot Water temperature too low.
Remedy: Adjuster the water heater, increase hot water temperature to 65 °C.
2. Crossflow, cold water being forced into hot water pipe, or vice versa, when valve is closed
Cause: Non-return valves dirty or leaking
Remedy: Clean the non-return valves or exchange if necessary
3. Very low flow or no flow
Cause: Supply pressure inadequate
Remedy: Check hot and cold feeds. If a pump has been installed, please check to see if the pump is working. (the valve will shut down if either the cold or hot water supply fails)
4. Water will not run hot enough when first installed
Cause: Wrong maximum temperature setting
Remedy: Adjust the maximum temperature, refer to "Temperature Setting" procedure.

CLEANING

We do NOT recommend you use any household cleaners to clean the product, because these cleaners change substance or formula too frequently. So product should be always cleaned only with soapy water and rinsing with clean water and drying with soft cloth.